

BEFORE THE ILLINOIS POLLUTION CONTROL BOARD

RECORDED  
CLERK'S OFFICE

ARCLAR COMPANY, LLC )  
Coal Preparation Facility - Willow Lake )  
PROPERTY IDENTIFICATION NUMBER )  
09-01-300-001-0080 )  
)  
)

DEC 16 2003  
04-95  
PCB ~~03~~  
STATE OF ILLINOIS  
Pollution Control Board  
(Tax Certification)

NOTICE

TO: Dorothy Gunn, Clerk  
Illinois Pollution Control Board  
State of Illinois Center  
100 W. Randolph Street, Suite 11-500  
Chicago, Illinois 60601

Donald Coovert  
5949 Beau Jardine Drive  
Indianapolis, Indiana 46237

Steve Santarelli  
Illinois Department of Revenue  
101 West Jefferson  
P.O. Box 19033  
Springfield, Illinois 62794

PLEASE TAKE NOTICE that I have today filed with the Office of the Pollution Control Board the APPEARANCE AND RECOMMENDATION of the Illinois Environmental Protection Agency, a copy of which is herewith served upon you.

By: Robb H. Layman  
Robb H. Layman  
Special Assistant Attorney General  
ARDC #6205498

Date: December 16, 2003

ILLINOIS ENVIRONMENTAL PROTECTION AGENCY  
1021 North Grand Avenue East  
P.O. Box 19276  
Springfield, IL 62794-9276  
Telephone: 217/782-5544  
Facsimile: 217/782-9807

THIS FILING IS SUBMITTED ON RECYCLED PAPER

BEFORE THE ILLINOIS POLLUTION CONTROL BOARD

ARCLAR COMPANY, LLC )  
 Coal Preparation Facility - Willow Lake )  
 )  
 PROPERTY IDENTIFICATION NUMBER )  
 09-01-300-001-0080 )  
 )  
 )

04-95  
 PCB 03-  
 (Tax Certification)

APPEARANCE

I hereby file my Appearance in this proceeding on behalf of the Illinois Environmental Protection Agency.

By: Robb H. Layman  
 Robb H. Layman  
 Special Assistant Attorney General  
 ARDC #6205498

DATED: December 16, 2003

ILLINOIS ENVIRONMENTAL PROTECTION AGENCY

1021 North Grand Avenue East  
 P.O. Box 19276  
 Springfield, Illinois 62794-9276  
 Telephone: 217/782-5544  
 Facsimile: 217/782-9807

THIS FILING IS SUBMITTED ON RECYCLED PAPER

BEFORE THE ILLINOIS POLLUTION CONTROL BOARD

ARCLAR COMPANY, LLC	)	
Coal Preparation Facility – Willow Lake	)	
	)	
PROPERTY IDENTIFICATION NUMBER	)	04-95 PCB 03-
09-01-300-001-0080	)	(Tax Certification)
	)	
	)	

RECOMMENDATION

NOW COMES the ILLINOIS ENVIRONMENTAL PROTECTION AGENCY (“Illinois EPA”), through its attorneys, and pursuant to 35 Ill. Adm. Code 125.204 of the ILLINOIS POLLUTION CONTROL BOARD’S (“Board”) regulations, files the Illinois EPA’s Recommendation in the above-referenced tax certification request of air pollution control facilities. In support thereof, the Illinois EPA states as follows:

1. On October 16, 2003, the Illinois EPA received a request and supporting information from ARCLAR COMPANY, LLC (“Arclar”) concerning the proposed tax certification of air pollution control facilities for certain sources and/or equipment located at its Willow Lake facility. A copy of the relevant portions of the application is attached hereto.

[Exhibit A].

2. Additional information concerning the property identification numbers was faxed to the Illinois EPA on November 13, 2003. [Exhibit B].

3. The applicant’s address is as follows:

Arclar Company, LLC  
 Attention: Mr. Donald Coover  
 5949 Beau Jardine Drive  
 Indianapolis, Indiana 46237

4. The air pollution control facilities involved in this request are located at 420 Long Lane Road, Equality, Saline County, Illinois 62934 and consist of the following:

Coal Preparation Facility whose primary purpose is to remove, through a coal washing process, the sulfur and ash from the coal. The coal washing process reduces sulfur dioxide and particulate matter emissions, which are regulated air pollutants.

5. Section 11-10 of the Property Tax Code, 35 ILCS 200/11-10 (2002), defines "pollution control facilities" as:

"any system, method, construction, device or appliance appurtenant thereto, or any portion of any building or equipment, that is designed, constructed, installed or operated for the primary purpose of: (a) eliminating, preventing, or reducing air or water pollution... or (b) treating, pretreating, modifying or disposing of any potential solid, liquid, gaseous pollutant which if released without treatment, pretreatment, modification or disposal might be harmful, detrimental or offensive to human, plant or animal life, or to property."

6. Pollution control facilities are entitled to preferential tax treatment, as provided by 35 ILCS 200/11-5 (2002).

7. Based on information in the application and the underlying purpose of the facilities to prevent, eliminate or reduce air pollution, it is the Illinois EPA engineering judgment that the described facilities may be considered as "pollution control facilities" in accordance with the statutory definition and consistent with the Board's regulations at 35 Ill. Adm. Code 125.200.

8. Because the described facilities satisfy the aforementioned criterion, the Illinois EPA recommends that the Board issue the applicant's requested tax certification.

Respectfully submitted,  
ILLINOIS ENVIRONMENTAL PROTECTION AGENCY

By: *Robb H. Layman*  
Robb H. Layman  
Special Assistant Attorney General  
ARDC #6205498

DATED: December 16, 2003

ILLINOIS ENVIRONMENTAL PROTECTION AGENCY

1021 North Grand Avenue East  
P.O. Box 19276  
Springfield, Illinois 62794-9276  
Telephone: 217/782-5544  
Facsimile: 217/782-9807

THIS FILING IS SUBMITTED ON RECYCLED PAPER

PROOF OF SERVICE

I, the undersigned, certify that I have served the attached Appearance and Recommendation upon the person to whom it is directed, by placing them in an envelope addressed to:

TO: Dorothy Gunn, Clerk  
Illinois Pollution Control Board  
State of Illinois Center  
100 W. Randolph Street, Suite 11-500  
Chicago, Illinois 60601

Donald Coover  
5949 Beau Jardine Drive  
Indianapolis, Indiana 46237

Steve Santarelli  
Illinois Department of Revenue  
101 West Jefferson  
P.O. Box 19033  
Springfield, Illinois 62794

and mailing it by First Class Mail from Springfield, Illinois on December 16, 2003. A copy of the attached documents was also filed by facsimile with the Board on this same date.

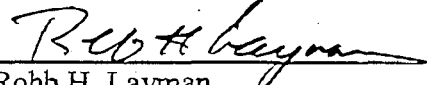
  
Robb H. Layman  
Special Assistant Attorney General  
ARDC #6205498

THIS FILING IS SUBMITTED ON RECYCLED PAPER

TC-03-10-16

165102 AAB



PEABODY ENERGY

1970 Barrett Court  
P.O. Box 1990  
Henderson, Kentucky 42419-1990  
270.827.0600  
270.827.6221 (Writer's Direct)  
270.827.6278 (Fax)

DAVID R. JOEST  
Counsel

October 14, 2003

Mr. Donald E. Sutton  
Permit Section  
Division of Air Pollution Control  
Illinois Environmental Protection Agency  
P.O. Box 19276  
Springfield, Illinois 62794-9276

**RE: Arclar Company, LLC  
Willow Lake Preparation Plant  
Application for Certification of Pollution Control Facility  
(Air) (Property Tax Treatment)**

Dear Mr. Sutton:

Enclosed please find an original and one copy of Arclar Company, LLC's application for certification of its Willow Lake Preparation Plant as an air pollution control facility.

Arclar has designated Donald Coovert as its representative for purposes of contact and receipt of the certification. Mr. Coovert's address and telephone number appear in the application. Please contact him if you require any further information.

Very truly yours,

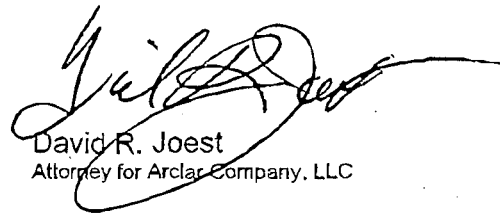
  
David R. Joest  
Attorney for Arclar Company, LLC

Enclosures

cc: D. Coovert  
A. Jackson (w/o encl)

RECEIVED  
OCT 16 2003  
EPA - OAPC - SPRINGFIELD

APPLICATION FOR CERTIFICATION (PROPERTY TAX TREATMENT)  
 POLLUTION CONTROL FACILITY  
 AIR  WATER

ILLINOIS ENVIRONMENTAL PROTECTION AGENCY  
 P. O. Box 19276, Springfield, IL 62794-9276

This Agency is authorized to request this information under Illinois Revised Statutes, 1979, Chapter, 120, Section 502a-5. Disclosure of this information is voluntary. However, failure to comply could prevent your application from being processed or could result in denial of your application for certification.

FOR AGENCY USE

File No.	Date Received	Certification No.	Date
Sec. A          APPLICANT	Company Name <b>Arclar Company, LLC</b>		<b>Donald Coovert</b>
	Person Authorized to Receive Certification <b>Donald Coovert</b>		Person to Contact for Additional Details <b>Donald Coovert</b>
	Street Address <b>5949 Beau Jardine Drive</b>		Street Address <b>5949 Beau Jardine Drive</b>
	Municipality, State & Zip Code <b>Indianapolis, IN 46237</b>		Municipality, State & Zip Code <b>Indianapolis, IN 46237</b>
	Telephone Number <b>(317) 781-2950</b>		Telephone Number <b>(317) 781-2950</b>
	Location of Facility Quarter Section Township Range <b>SW 1/4 Sec. 1 9S 7E</b>		Municipality Township <b>Cottage</b>
	Street Address <b>420 Long Lane Road, Equality, IL 62934</b>		County Book Number <b>Saline</b>
	Property Identification Number		Parcel Number
	Sec. B     MANUFACTURING OPERATIONS	Nature of Operations Conducted at the Above Location <b>Underground coal mine portal and coal preparation plant and loadout.</b>	
Water Pollution Control Construction Permit No. <b>N/A</b>		Date Issued	
NPDES PERMIT No. <b>IL 0066664</b>		Date Issued <b>June 30, 1999</b>	
Air Pollution Control Construction Permit No. <b>165802 AAB</b>		Expiration Date <b>March 31, 2004</b>	
Air Pollution Control Operating Permit No. <b>165802AAB</b>		Date Issued <b>July 29, 2002</b>	
Sec. C    MANUFACTURING PROCESS	Describe Unit Process <b>Coal washing facility that removes ash, rock and sulfur from the raw coal product to produce a clean coal product.</b>		
	Materials Used in Process <b>Raw coal/water/magnetite/floculant</b>		
Sec. D   POLLUTION CONTROL FACILITY DESCRIPTION	Describe Pollution Abatement Control Facility <b>Please see Flow Chart of Preperation Plant and Description of Prep Plant Process.</b>		

RECEIVED  
 OCT 16 2003  
 EPA - DAPC - 28811

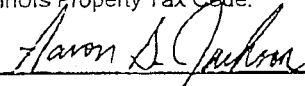
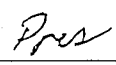

POLLUTION CONTROL FACILITY - CONTAMINANTS       ACCOUNTING DATA	Sec. E (1) Nature of Contaminants or Pollutants		
		Material Retained, Captured or Recovered	
	Contaminant or Pollutant	DESCRIPTION	DISPOSAL OR USE
	Coarse Refuse	Rock Waste	Trucked to Pit for disposal
	Slurry	<100 mesh material	Pumped to old works for disposal
	Sec. E (2) Point(s) of Waste Water Discharge See attached map for locations		
		Plans and Specifications Attached	Yes <input checked="" type="checkbox"/> No
	(3)	Are contaminants (or residues) collected by the control facility?	Yes <input checked="" type="checkbox"/> No
	(4)	Date installation completed <u>4/2002</u> status of installation on date of application <u>operating</u>	
	(5)	a. FAIR CASH VALUE IF CONSIDERED REAL PROPERTY:	\$ <u>3,500,110.00</u>
	b. NET SALVAGE VALUE IF CONSIDERED REAL PROPERTY: *	\$ <u>0</u>	
	c. PRODUCTIVE GROSS ANNUAL INCOME OF CONTROL FACILITY:	\$ <u>0</u>	
	d. PRODUCTIVE NET ANNUAL INCOME OF CONTROL FACILITY:	\$ <u>0</u>	
	e. PERCENTAGE CONTROL FACILITY BEARS TO WHOLE FACILITY VALUE:	% <u>100</u>	

SIGNATURE	Sec. F The following information is submitted in accordance with the Illinois Property Tax Code, as amended, and to the best of my knowledge, is true and correct. The facilities claimed herein are "pollution control facilities" as defined in Section 11-10 of the Illinois Property Tax Code.
	<div style="display: flex; justify-content: space-between;"> <div style="text-align: center;">                   Signature             </div> <div style="text-align: center;">                   Title             </div> </div>

INSTRUCTIONS	Sec. G INSTRUCTIONS FOR COMPILING AND FILING APPLICATION						
	General: Separate applications must be completed for each control facility claimed. Do not mix types (water and air). Where both air and water operations are related, file two applications. If attachments are needed, record them consecutively on an index sheet.						
Sec. A	Information refers to applicant as listed in the tax records and the person to be contacted for further details or for inspection of facilities. Define facility location by street address or legal description. A plat map location is required for facilities located outside of municipal boundaries. The property identification number is required.						
Sec. B	Self-explanatory. Submit copies of all permits issued by local pollution control agencies. (e.g. MSD Construction Permit)						
Sec. C	Refers to manufacturing processes or materials on which pollution control facility is used.						
Sec. D	Narrative description of the pollution control facility, indicating that its primary purpose is to eliminate, prevent or reduce pollution. State the type of control facility. State permit number, date, and agency issuing permit. A narrative description and a process flow diagram describing the pollution control facility. Include a listing of each major piece of equipment included in the claimed fair cash value for real property. Include an average analysis of the influent and effluent of the control facility stating the collection efficiency.						
Sec. E	List air contaminants, or water pollution substances released as effluents to the manufacturing processes. List also the final disposal of any contaminants removed from the manufacturing processes. Item (1) - Refers to pollutants and contaminants removed from the process by the pollution control facility. Item (2) - Refers to water pollution but can apply to water-carried wastes from air pollution control facilities. Submit drawings, which clearly show (a) Point(s) of discharge to receiving stream, and (b) Sewers and process piping to and from the control facility. Item (3) - If the collected contaminants are disposed of other than as wastes, state the disposition of the materials, and the value in dollars reclaimed by sale or reuse of the collected substances. State the cost of reclamation and related expense. Item (4) - State the date which the pollution control facility was first placed in service and operated. If not, explain. Item (5) - This information is essential to the certification and assessment actions. This accounting data must be completed to activate project review prior to certification by this Agency.						
Sec. F	Self-explanatory. Signature must be a corporate authorized signature.						
	<table border="0" style="width: 100%;"> <tr> <td style="width: 33%;">Submit to:</td> <td style="width: 33%;">Attention:</td> <td style="width: 33%;">Attention:</td> </tr> <tr> <td>Illinois EPA P.O. Box 19276 Springfield, IL 62794-9276</td> <td>Thomas McSwiggin Permit Section Division of Water Pollution Control</td> <td>Donald E. Sutton Permit Section Division of Air Pollution Control</td> </tr> </table>	Submit to:	Attention:	Attention:	Illinois EPA P.O. Box 19276 Springfield, IL 62794-9276	Thomas McSwiggin Permit Section Division of Water Pollution Control	Donald E. Sutton Permit Section Division of Air Pollution Control
Submit to:	Attention:	Attention:					
Illinois EPA P.O. Box 19276 Springfield, IL 62794-9276	Thomas McSwiggin Permit Section Division of Water Pollution Control	Donald E. Sutton Permit Section Division of Air Pollution Control					

\* Cost of reclamation exceeds salvage value.

4<sup>th</sup> FLOOR - ELEV. 460

- 1) Head Pulley - Feed at 1200 tons/hr. Flop gate splits the feed evenly.
- 2) Mag Separator - Recovery of heavy media Magnetite (6X density of water).
- 3) 20' Cyclones (6 ea.) feed from sumps 6 & 6A underflow to refuse, overflow to thickener tank.
- 4) 15' Cyclones (10 ea.) feed from sumps 1 & 1A. Underflow to triple start spirals. Overflow to sumps 6 & 6A.
- 5) 10' Cyclones (3 ea.) feed from sump 8. Underflow to fine coal screens (-100 M). Overflow to thickener tank.

3<sup>rd</sup> FLOOR - ELEV. 438

- 1) Raw Coal Screens, 2 each, 10'x 20', (desliming screens). Separates coal at 3/8". Plus 3/8" to heavy media vessel. Minus 3/8" to heavy media cyclone.
- 2) Heavy Media Vessel - Specific gravity of 1.45 to 1.55 separates coal and non-coal. Coal goes to coarse coal screens. Non-coal to coarse refuse screen. Heavy media vessel feeds from No. 2 sump.
- 3) Heavy Media Cyclone (40 inch) feed minus 3/8" material from Sump No. 5. Coal goes out the overflow to small coal screens. Non-coal goes out underflow to horizontal refuse screen. Operates at 1.45 to 1.55 specific gravity.
- 4) Spirals - Two triple starts and one double start. Feed from 10" cyclones. Separates into coal, middlings, and refuse. Coal to fine coal screens, middlings to No. 7 Sump (double start spirals), refuse to fine refuse screens.

2<sup>nd</sup> FLOOR - ELEV. 414/418

- 1) Fine Coal Screens (3 ea., 5'x 12') Filter water and fines from coal. Feed from 15" cyclones. Fines and water to No. 8 Sump (10" cyclone feed). Coal goes to CMI 42" centrifugal dryers.
- 2) Small Coal Screens (2 ea., 6'x 20') Feed from 40" heavy media cyclone. Discharge to two each Tema dryers. Heavy media recovered and sent to Mag separators.
- 3) Coarse Coal Screens (2 ea., 6' x 20') Feed from heavy media vessel. Separates coal at +3/4" to clean coal belt, minus 3/4" to two each Tema dryers. Heavy media recovered and sent to Mag separators.
- 4) Fine Refuse Screens (2 ea., 5'x 12') Feed from 20' cyclones and spirals. Dewatered material to refuse belt, fines and water to thickener tank.
- 5) Horizontal Refuse Screen (1 ea., 8'x 16') Feed from 40" heavy media cyclone. Dewatered material to refuse belt, fines and water to heavy media circuit or Mag separators.
- 6) Coarse Refuse Screen (1 ea., 10'x 20') Feed from heavy media vessel (non-coal). Dewatered material to refuse belt, fines, water and heavy media back to heavy media circuit or Mag separators.

1<sup>st</sup> FLOOR - ELEVATION 400

- 1) Fine Coal Dryers (2 ea., 42" CMI dryers) Feed from fine coal screens. Dry coal to clean coal belt. Water and fines to 10" cyclone Feed Pump No. 8.
- 2) Coarse Coal Dryers (2 ea. Tema 1300 dryers) Feed from coarse coal (-3/4") and small coal screens. Dry coal to clean coal belt. Water, fines, some heavy media back to Mag separators.
- 3) Refuse Belt - Feed from 2 each fine refuse screens; one each horizontal refuse screen; and one each coarse refuse screen.

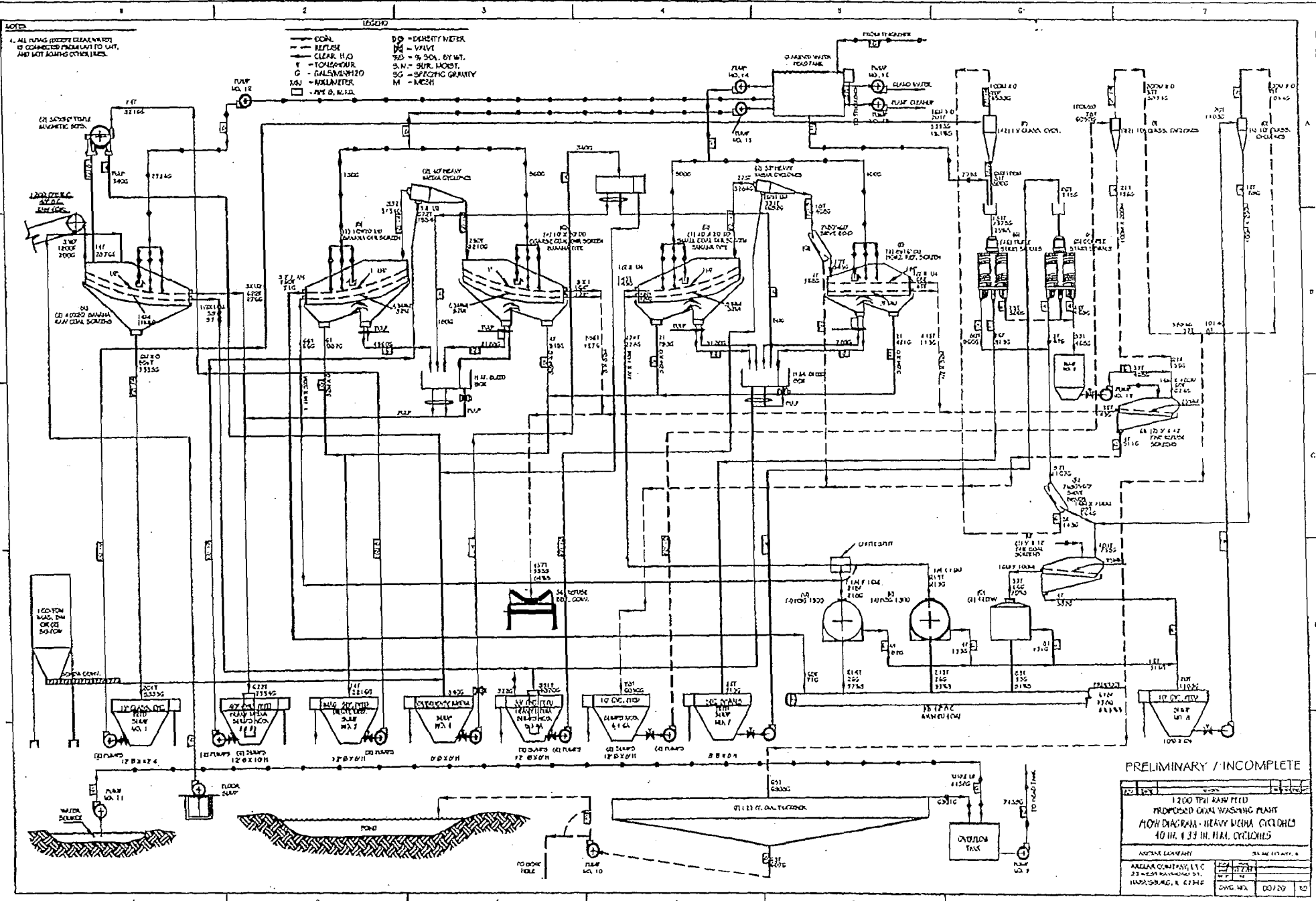

# ATTACHMENT NO. 1 UNDERGROUND SOLID REFUSE DISPOSAL FLOW CHART

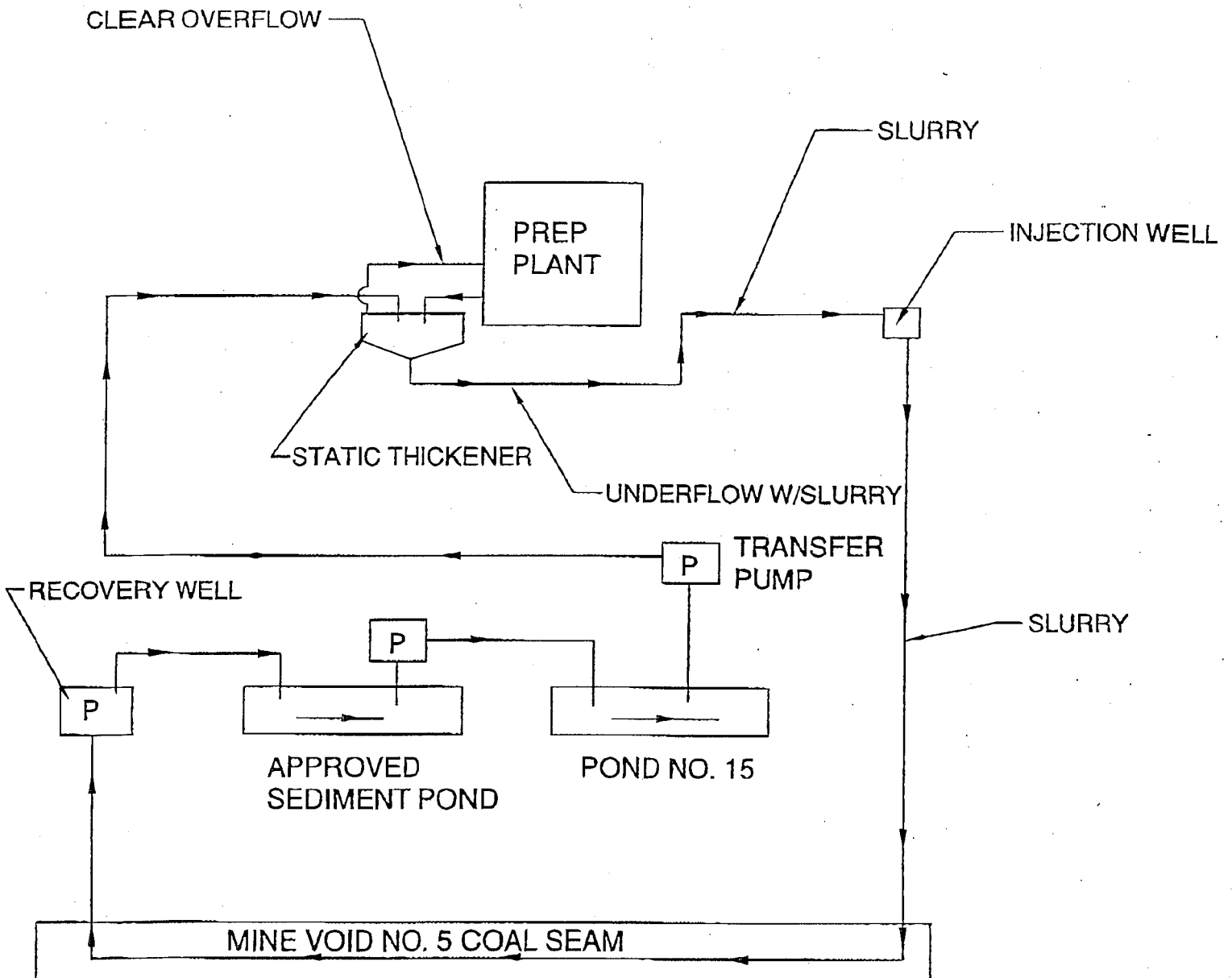

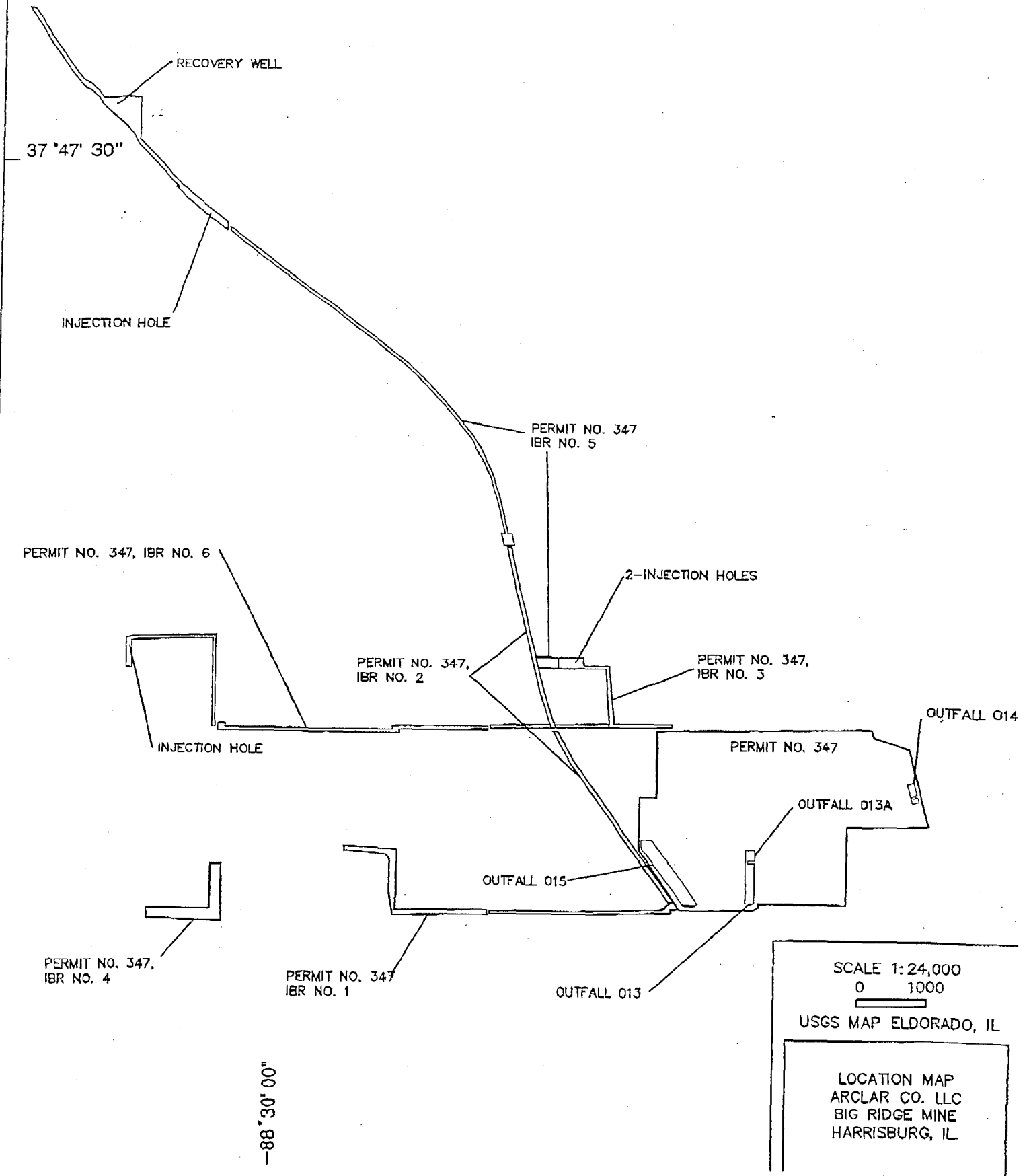



PEABODY ENERGY

DAVID R. JOEST  
Counsel1270 Barlett Court  
P.O. Box 1990  
Henderson, Kentucky 42419-1990  
270.827.0800  
270.827.8221 (Writer's Direct)  
270.827.8278 (Fax)

October 14, 2003

Mr. Donald E. Sutton  
Permit Section  
Division of Air Pollution Control  
Illinois Environmental Protection Agency  
P.O. Box 19276  
Springfield, Illinois 62794-9276

RE: Arclar Company, LLC  
Willow Lake Preparation Plant  
Application for Certification of Pollution Control Facility  
(Air) (Property Tax Treatment)

Dear Mr. Sutton:

Enclosed please find an original and one copy of Arclar Company, LLC's application for certification of its Willow Lake Preparation Plant as an air pollution control facility.

Arclar has designated Donald Coover as its representative for purposes of contact and receipt of the certification. Mr. Coover's address and telephone number appear in the application. Please contact him if you require any further information.

Very truly yours,

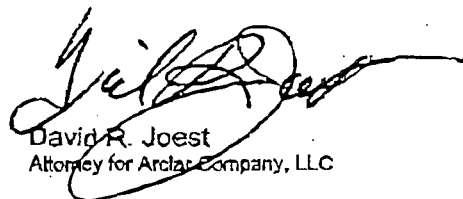

David R. Joest  
Attorney for Arclar Company, LLC

Enclosures

cc: D. Coover ✓  
A. Jackson (w/o encl)

APPLICATION FOR CERTIFICATION (PROPERTY TAX TREATMENT)  
 POLLUTION CONTROL FACILITY  
 AIR  WATER

ILLINOIS ENVIRONMENTAL PROTECTION AGENCY  
 P. O. Box 19278, Springfield, IL 62794-9278

This Agency is authorized to request this information under Illinois Revised Statutes, 1979, Chapter, 120, Section 502-5. Disclosure of this information is voluntary. However, failure to comply could prevent your application from being processed or could result in denial of your application for certification.

FOR AGENCY USE			
File No.	Date Received	Certification No.	Date
APPLICANT	Sec. A Company Name <b>Arclar Company, LLC</b>		<b>Donald Coovert</b>
	Person Authorized to Receive Certification <b>Donald Coovert</b>		Person to Contact for Additional Details <b>Donald Coovert</b>
	Street Address <b>5949 Beau Jardine Drive</b>		Street Address <b>5949 Beau Jardine Drive</b>
	Municipality, State & Zip Code <b>Indianapolis, IN 46237</b>		Municipality, State & Zip Code <b>Indianapolis, IN 46237</b>
	Telephone Number <b>(317) 781-2950</b>		Telephone Number <b>(317) 781-2950</b>
	Location of Facility Quarter Section Township Range		Municipality Township
	<b>SW 1/4 Sec. 1 9S 7E</b>		<b>Cottage</b>
	Street Address <b>420 Long Lane Road, Equality, IL 62934</b>		County Book Number <b>Saline</b>
	Property Identification Number <b>09-01-200-001-0020</b>		Parcel Number
	MANUFACTURING OPERATIONS	Sec. B Nature of Operations Conducted at the Above Location <b>Underground coal mine partial and coal preparation plant and loadout.</b>	
Water Pollution Control Construction Permit No. <b>N/A</b>		Date Issued	
NPDES PERMIT No. <b>IL 0066664</b>		Date Issued <b>June 30, 1999</b>	Expiration Date <b>March 31, 2004</b>
Air Pollution Control Construction Permit No. <b>165802 AAB</b>		Date Issued <b>July 29, 2002</b>	
Air Pollution Control Operating Permit No. <b>165802AAB</b>		Date Issued <b>August 1, 2003</b>	
MANUFACTURING PROCESS	Sec. C Describe Unit Process <b>Coal washing facility that removes ash, rock and sulfur from the raw coal product to produce a clean coal product.</b>		
	Materials Used in Process <b>Raw coal/water/magnetite/floculant</b>		
POLLUTION CONTROL FACILITY DESCRIPTION	Sec. D Describe Pollution Abatement Control Facility <b>Please see Flow Chart of Preperation Plant and Description of Prep Plant Process.</b>		

POLLUTION CONTROL FACILITY - CONTAMINANTS          ACCOUNTING DATA	Sec. E (1) Nature of Contaminants or Pollutants		
			Material Retained, Captured or Recovered
	Contaminant or Pollutant	DESCRIPTION	DISPOSAL OR USE
	Coarse Refuse	Rock Waste	Trucked to Pit for disposal
	Slurry	<100 mesh material	Pumped to old works for disposal
	(2) Point(s) of Waste Water Discharge See attached map for locations		
			Plans and Specifications Attached
	(3) Are contaminants (or residues) collected by the control facility?	Yes <input checked="" type="checkbox"/>	No <input type="checkbox"/>
	(4) Date installation completed <u>4/2002</u> status of installation on date of application <u>operating</u>		
	(5) a. FAIR CASH VALUE IF CONSIDERED REAL PROPERTY:	\$ 3,500,110.00	
b. NET SALVAGE VALUE IF CONSIDERED REAL PROPERTY: *	\$ 0		
c. PRODUCTIVE GROSS ANNUAL INCOME OF CONTROL FACILITY:	\$ 0		
d. PRODUCTIVE NET ANNUAL INCOME OF CONTROL FACILITY:	\$ 0		
e. PERCENTAGE CONTROL FACILITY BEARS TO WHOLE FACILITY VALUE:	% 100		

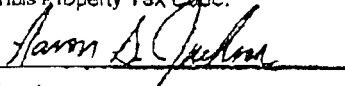
Sec. F  SIGNATURE	The following information is submitted in accordance with the Illinois Property Tax Code, as amended, and to the best of my knowledge, is true and correct. The facilities claimed herein are "pollution control facilities" as defined in Section 11-10 of the Illinois Property Tax Code.		
	 Signature	Pro Title	

Sec. G          INSTRUCTIONS	INSTRUCTIONS FOR COMPILING AND FILING APPLICATION		
General: Separate applications must be completed for each control facility claimed. Do not mix types (water and air). Where both air and water operations are related, file two applications. If attachments are needed, record them consecutively on an index sheet.			
Sec. A	Information refers to applicant as listed in the tax records and the person to be contacted for further details or for inspection of facilities. Define facility location by street address or legal description. A plat map location is required for facilities located outside of municipal boundaries. The property identification number is required.		
Sec. B	Self-explanatory. Submit copies of all permits issued by local pollution control agencies. (e.g. MSD Construction Permit)		
Sec. C	Refers to manufacturing processes or materials on which pollution control facility is used.		
Sec. D	Narrative description of the pollution control facility, indicating that its primary purpose is to eliminate, prevent or reduce pollution. State the type of control facility. State permit number, date, and agency issuing permit. A narrative description and a process flow diagram describing the pollution control facility. Include a listing of each major piece of equipment included in the claimed fair cash value for real property. Include an average analysis of the influent and effluent of the control facility stating the collection efficiency.		
Sec. E	List air contaminants, or water pollution substances released as effluents to the manufacturing processes. List also the final disposal of any contaminants removed from the manufacturing processes. Item (1) - Refers to pollutants and contaminants removed from the process by the pollution control facility. Item (2) - Refers to water pollution but can apply to water-carried wastes from air pollution control facilities. Submit drawings, which clearly show (a) Point(s) of discharge to receiving stream, and (b) Sewers and process piping to and from the control facility. Item (3) - If the collected contaminants are disposed of other than as wastes, state the disposition of the materials, and the value in dollars reclaimed by sale or reuse of the collected substances. State the cost of reclamation and related expense. Item (4) - State the date which the pollution control facility was first placed in service and operated. If not, explain. Item (5) - This information is essential to the certification and assessment actions. This accounting data must be completed to activate project review prior to certification by this Agency.		
Sec. F	Self-explanatory. Signature must be a corporate authorized signature.		
	Submit to:  Illinois EPA P.O. Box 19278 Springfield, IL 62794-9278	Attention:  Thomas McSwiggin Permit Section Division of Water Pollution Control	Attention:  Donald E. Sutton Permit Section Division of Air Pollution Control

\* Cost of reclamation exceeds salvage value.



# Venture Management International, Ltd.

5949 Beau Jardin Drive  
Indianapolis, IN 46237

Phone: (317) 781-2950  
Fax: (317) 781-2948  
e-mail: DECcovert@aol.com

11 Pages, including cover **Fax Cover Sheet**

### CONFIDENTIAL AND PROPRIETARY INFORMATION

This document contains information, which is privileged, proprietary and confidential. It is for the exclusive use of the addressee only. Please note that distribution, dissemination, copying or use of this document, or the concepts contained within is strictly prohibited. If you have received this document in error, please telephone immediately to arrange for prompt return.

RECEIVED

NOV 17 2003

### RECIPIENT INFORMATION

IEPA-DAPC-SFIELD

FAX NUMBER:

217/524-5023

DELIVER TO:

Floyd McKinney

COMPANY:

Illinois EPA

DATE:

11/13/03

RECIPIENT'S PHONE:

217/782-7187

### SENDER INFORMATION

SENDER:

Don Covert

PHONE:

FAX:

VOICE MAIL/PAGING:

CELL PHONE:

888/270-3973

ALTERNATE PHONE:

- A hard copy of this document  will be sent by regular mail.
- will be sent via overnight mail.
- will not be sent under separate cover.

COMMENTS: Floyd - Thanks for the fax#. Here is the info you need. Let me know if you need anything further. Thanks for your help.

Don

STATUS:  Urgent  For Your Review  Reply ASAP  Please Comment

Floyd:

You should have three pollution control facility certification applications from Peabody Energy for prep. plants operated by two subsidiaries. The identifying information along with the property identification numbers you need are summarised below:

	<u># 1</u>	<u># 2</u>	<u># 3</u>
Appl. Date	10/14/03	10/20/03	10/20/03
Subsidiary	Arcor	Black Beauty	Black Beauty
Facility Name	Willow Lake	Rock Portal	Vermilion Grove
County	Saline	Vermilion	Vermilion
Sec, Twp, Rge	1, 9S, 7E	33, 18N, 12W	13, 17N, 12W
FC Value	3,500,110	363,222	3,875,625
Prop ID #	07-01-300-001-0080	27-33-200-004-8068	32,13-100-014-0060

Please confirm receipt of this information and that you have all three applications by calling my toll free cell phone @ 888/270-3973. Also, let me know if you need any further information.

Thanks for your help.

Don Covert

RECEIVED

NOV 17 2003

RECEIVED

ALL INFORMATION CONTAINED HEREIN IS UNCLASSIFIED

DATE 12-16-2003

STATE OF ILLINOIS  
Pollution Control Board

ILLINOIS ENVIRONMENTAL PROTECTION AGENCY  
DIVISION OF LEGAL COUNSEL  
- 1021 NORTH GRAND AVENUE EAST, POST OFFICE BOX 19276  
SPRINGFIELD, ILLINOIS 62794-9276  
TELEPHONE (217)782-5544 • FACSIMILE (217)782-9307

DATE: December 16, 2003

FACSIMILE TRANSMITTAL SHEET

PLEASE DELIVER THE FOLLOWING PAGE(S) TO:

PARTY'S NAME: Ms. Dorothy Gunn  
Clerk

FIRM/COMPANY'S NAME: Pollution Control Board

FACSIMILE NO.: \_\_\_\_\_

TELEPHONE NO.: \_\_\_\_\_

FROM: Robb Layman

Re: Tax certification pleadings

TOTAL NUMBER OF PAGES (INCLUDING THIS PAGE): 19

HARD COPY WILL X WILL NOT \_\_\_\_\_ FOLLOW.

IF YOU DO NOT RECEIVE ALL OF THE PAGES, PLEASE CALL 217-782-5544.

COMMENTS: Arclar Company, LLC - Willow  
lake facility

IMPORTANT - THIS MESSAGE IS INTENDED ONLY FOR THE USE OF THE INDIVIDUAL OR ENTITY TO WHICH IT IS ADDRESSED; AND MAY CONTAIN INFORMATION THAT IS PRIVILEGED, CONFIDENTIAL, AND EXEMPT FROM DISCLOSURE UNDER APPLICABLE LAW. IF THE READER OF THE MESSAGE IS NOT THE INTENDED RECIPIENT, OR THE EMPLOYEE OR AGENT RESPONSIBLE TO DELIVER IT TO THE INTENDED RECIPIENT, YOU ARE HEREBY NOTIFIED THAT READING, DISSEMINATING, DISTRIBUTING, OR COPYING THIS COMMUNICATION IS STRICTLY PROHIBITED. IF YOU HAVE RECEIVED THIS COMMUNICATION IN ERROR, PLEASE IMMEDIATELY NOTIFY US BY TELEPHONE, AND RETURN THE ORIGINAL MESSAGE TO US AT THE ABOVE ADDRESS VIA THE U.S. POSTAL SERVICE. THANK YOU.